

Aurora Town Square

Heritage, Programming & Special Events

September 25, 2023





Aurora Town Square

Aurora will no longer be York Region's best kept secret — it will become the cultural destination for those escaping the big city. Take a seat while we welcome and captivate you with our small-town charm.





Heritage at Town Square

Aurora Town Square will be the headquarters for heritage services and activities offered by the Town of Aurora, through the Aurora Museum & Archives.

Heritage Services and Activities

Initiated by the Community

 Research Requests

 Image Requests

 Donation Inquiries

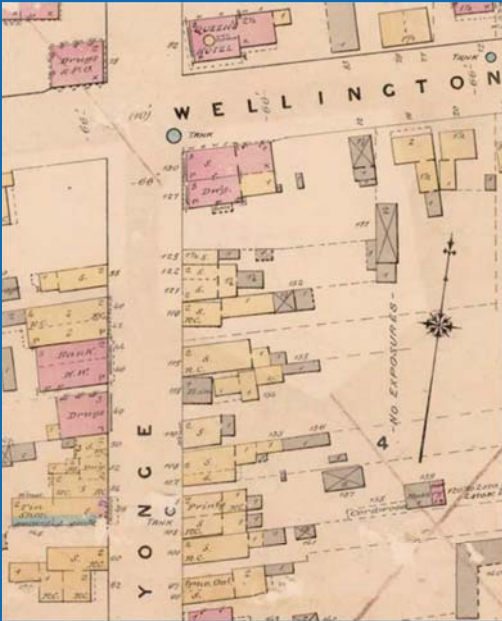

Fire Insurance Map, 1880 amended to 1885

Heritage Services and Activities

Initiated by Staff

-  Collections Care
-  Ongoing Documentation
-  Educational Programs
-  Curatorial/Exhibitions



Display to commemorate 100th Anniversary of the Battle of Vimy Ridge.

Exhibition Opportunities

New Addition



Four Museum Grade Display Cases



Picture Hanging Rail



Flexible Use and will Rotate Regularly



Connect with Local, National, and Global Cultural Celebrations



Collaborate with Cultural Partners and Community Organizations

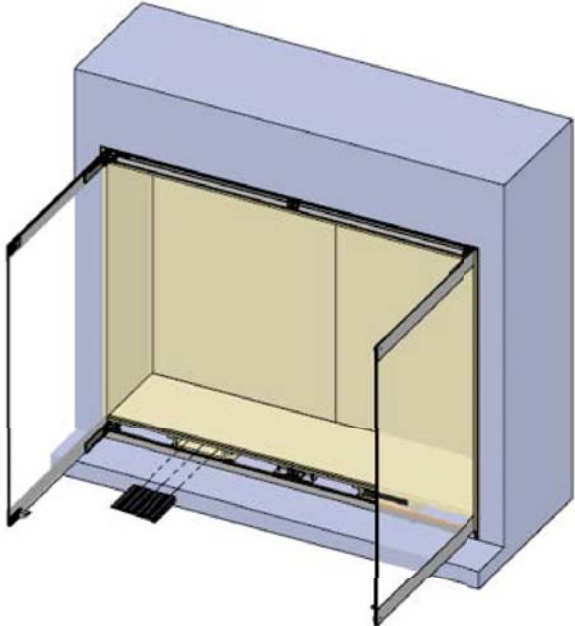

Exhibition Opportunities

The Aurora Room

-  730 Square Feet
-  Long Term Exhibition with Curriculum Connections
-  Explore the Passage of Time Through a Thematic Approach
-  Broaden the Understanding of the Historical Record
-  Feature a Mural by an Indigenous Artist

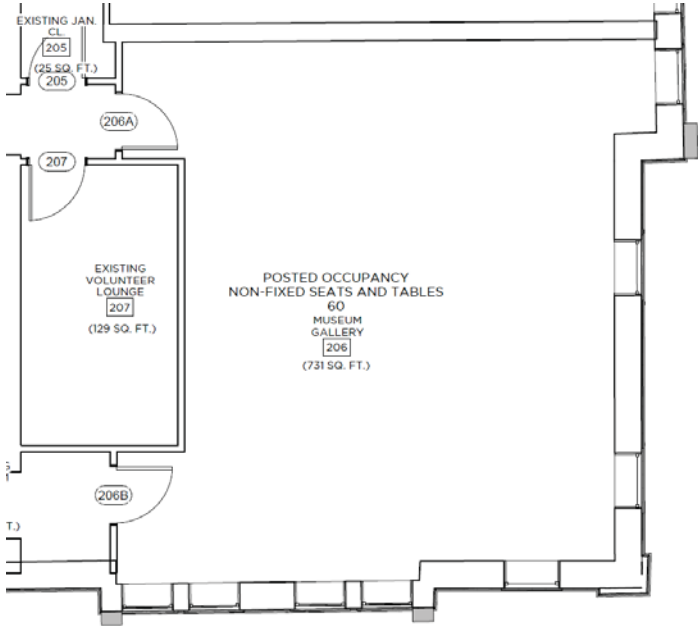

Community Perspective

“Recently, I decided it was time to downsize and find new homes for some of my treasured possessions. At the top of my list was my collection of international dolls. I called, sent emails, and did a lot of research on where I could donate my dolls. I had a lot of negative responses to this request until I heard from the Aurora Museum & Archives.

Their response to my request was heartwarming. This is exactly where I was hoping my dolls would find a new home. When I delivered my dolls, we looked at them together and I explained a little about each doll and how I had acquired it. Staff were attentive and genuinely interested in the information I shared. I appreciate that.

As a long-time Aurora resident (my father and mother, Bill and Minda Williams bought the Scanlon Bakery in 1960) I am truly grateful for the response I had from the Aurora Museum & Archives. I look forward to seeing some of my “old friends” on display when the new museum opens.”

- Gwyn Gallant





New Collection Storage Space

The addition features a 1,900 sq/ft visible collection storage space that allows Town Square visitors to see through a large glass partition into the room where artifacts are stored, and collections care activities are taking place.

The previously invisible aspects of museum work (collections care) can now be front and centre.

Programming

Programming at Aurora Town Square will provide an opportunity to connect members of the community in a shared love for, and education in arts, culture and heritage. It's an opportunity to foster the love of learning and growth in a welcoming and community-based setting.

Members of the community will embark on a thrilling journey when they attend a live performance, program, or event at Town Square, expanding their horizons and creating significant community connections.

Programs

at Town Square



Education Programs



Community Programs



Special Workshops



Performances



Education Programs

- Creating connections through hands-on activity, social interaction and in-person experiences
- Aurora Museum & Archives
- Diversity, Equity & Inclusion
 - Public Art
 - Theatre
- Expanding partnerships
- Curriculum connections



Community Programs

- Existing Town programs
 - Music
 - Dance
 - Theatre
- Museum Programs



Special Workshops

- All ages
- Themed
- Partnership opportunities

Performances



Live Music



Theatre



Comedy



Cultural Experiences



Culture Days

- New home of Aurora Culture Days
- One central location with design features suited to best support programs and events
- Increased support for Cultural Partners' programming
- Enhanced community experience





Community Support

Cultural Partner Perspective

"We are thrilled to announce that, in 2024, our Annual Induction Celebration Evening will now find its home at the Aurora Town Square. This incredible space perfectly encapsulates the essence of community, providing the ideal location to honour and celebrate the exceptional sport legends who have graced our town. Whether as athletes, coaches, or builders, these individuals have left an indelible mark on our sporting heritage, and it is only fitting that we gather in this symbolic venue to recognize their excellence.

Just as the Aurora Sports Hall of Fame serves as a unifying force, the Aurora Town Square stands as a beacon of unity, bringing together our community through shared values and collective pride. This new partnership not only enhances the event experience, it also strengthens our commitment to preserving the sporting legacy that defines our town and its people."

- Javed S. Khan, President & Chair, Aurora Sports Hall of Fame





Special Events

at Town Square

Aurora Town Square will provide new and enhanced special event opportunities for not only Aurora, but York Region and beyond. This dynamic and engaging space will strengthen our community and our cultural fabric as it becomes a true York Region gem.

Special Events

Creating Connections

The Importance of Events:

- Proven economic drivers
- Key catalyst for community engagement
- Essential tonic for community survival and connectivity
- Immeasurable contributions to our social fabric and for educating us on people and place

Special Events

Events Refreshed in Town Square:

- Aurora's Art Show and Sale
- Aurora's Performing Arts Festival
- Aurora's Christmas Market
- Aurora's Menorah Lighting Ceremony



Special Events

Events expanded and enhanced in
Town Square:

- Aurora's Arctic Adventure
- Saturday Night Fever
- Aurora's Multicultural Festival
- Aurora's Family First Night



Special Events

Impact Town Square will have on Special Events:

- Refresh existing events
- Provide expansion opportunities
- Move people throughout the Cultural District
- The optimal landscape to work with more community partners on the Town's event delivery model

Special Events are living, evolving sources of energy that connect us in so many imaginative ways literally and figuratively. Town Square is essential as it is going to be an incredible catalyst for a plethora of new experiences, that will enhance the community's overall quality of life.

Your seat awaits



Aurora
Town
Square

AURORA